

Per te che abiti il mondo,
c'è Miami, una cucina
dall'anima cosmopolita.
Eclettica e al passo con
i tempi, si trasforma
ogni volta, perché mille
sono i modi di viverla.

MIAMI

For you, a citizen of
the world, we have
created Miami, a kitchen
with a cosmopolitan
soul. Eclectic and up
to date, it is different in
every installation, ideal
for a thousand different
lifestyles.

 **SPAR**
cucine



Dove cucina e living
si incontrano, c'è Miami.

Giovane, dinamica, poliedrica: è Miami.
Abbraccia con armonia la zona living
e ci dialoga idealmente attraverso pareti
attrezzate e moduli a vista che danno vita
a uno spazio elegante e funzionale.

Miami: where kitchen
and living area meet.
Young, dynamic and multifaceted:
Miami. It includes the living area in an
attractive embrace, dialoguing with it through
wall compositions and open modules that
create elegant, functional design schemes.



L'angolo della Casa.

Miami, dove tutto quello che cerchi lo trovi in cucina.

The corner of the house.

Miami, where everything you are looking for is in the kitchen.



La parete delle meraviglie.

Immagina una cucina dove l'angolo cottura è arredato con una parete ricca di strumenti per dare spazio alla propria creatività culinaria. Alla comodità degli spazi aggiungi un design semplice ed elegante, con top e mensole di stili e materiali diversi. La meraviglia di Miami, bella e funzionale.

The wall of wonders .

Imagine a kitchen where the kitchenette is furnished with a wall full of tools to give space to your culinary creativity. To the comfort of the spaces, add a simple and elegant design, with tops and shelves of different styles and materials. The wonder of Miami, beautiful and functional.



Il piacere di cucinare.

Miami non è solo uno spazio poliedrico che comunica con i diversi ambienti della casa grazie al suo design. Miami è anche il piacere di poter cucinare con comodità di spazi su materiali di qualità. Ogni dettaglio è articolato alla perfezione per darti una cucina perfettamente funzionale ma con uno stile unico.

The pleasure of cooking.

Miami is not just a multifaceted space that communicates with the different rooms of the house thanks to its design. Miami is also the pleasure of being able to cook with the comfort of spaces on quality materials. Every detail is perfectly articulated to give you a perfectly functional kitchen with a unique style.





Poliedrica, Miami

dialoga con il living.

Multi-faceted, Miami dialogues with the living area.



Ora il Design aggiunge l'utilità all'estetica.

È la cucina, più di tutti, lo spazio in cui si sente l'esigenza di un'organizzazione strutturale e formale degli elementi. Miami distribuisce i volumi in maniera intelligente, mixando colonne e basi con anta a ribalta che facilita l'apertura e migliora l'operatività. Così anche dove lo spazio non è generoso, Miami concentra efficientemente le diverse aree dedicate alla preparazione e dà vita a un habitat che è al contempo ordinato e accogliente.

Now Design adds practicality to style.

Of all the rooms in the home, the kitchen is the one where a carefully structured layout is most important. Miami distributes volumes with intelligence, mixing tall units and base units with flap doors, for easier opening and labour saving. So even where space is tight, Miami concentrates the various preparation areas efficiently, creating a habitat that is both neat and comfortable.





L'isola che c'è.

Miami è una cucina dal design internazionale, dove i mobili hanno una duplice funzione vale a dire contenitiva ed estetica ma soprattutto si arricchiscono della personalità di chi li sceglie. Così l'isola centrale, che concentra le aree del lavaggio e della cottura e insieme amplia il piano di lavoro, è anche il trait d'union tra cucina e living, perfettamente in linea con gli stili di vita più attuali.

An island in the stream.

Miami is a kitchen designed on international principles, where the units serve a dual purpose - storage and style - and above all take on the personality of their owner. The central island, which both contains the washing and cooking areas and expands the work surface available, is also the link between the kitchen and living areas, in line with the very latest lifestyles.





L'essenziale da vivere.

Grazie a un design elegante e giovane, Miami riesce a racchiudere più esperienze all'interno dello spazio cucina. Un ambiente polivalente dove trovare tutto l'essenziale per ogni momento della giornata.

The essential to live .

Thanks to an elegant and young design, Miami manages to enclose more experiences within the kitchen space. A multipurpose environment where you can find all the essentials for every moment of the day.





Componibilità evoluta.



Vivere easily, tra il desiderio di rifugiarsi all'interno e quello di mostrarsi all'esterno. Il linguaggio progettuale si rinnova con una composizione dinamica e giovane che interpreta appieno le potenzialità espressive dello spazio.

Di fronte al sistema di grandi colonne che svolgono la funzione contenitiva, si snoda una serie di elementi caratterizzati da un'anta dall'affascinante matericità che trasferisce all'ambiente un grande calore.

State-of-the-art modularity.

Living easily, enjoying an intimate refuge yet also presenting a fine face to the world. Design language is renewed in this young, dynamic composition that interprets the space's expressive potential to the full. Opposite the system of large tall units that provide plenty of storage, a series of units featuring a door of great tactile appeal give the room immense warmth.





Prospettive che
allargano gli orizzonti.
Horizon-widening perspectives.

In primo piano.

Ricerca l'essenzialità delle linee non significa rinunciare alla funzionalità né all'estetica. Ecco che il piano, perfetto nei volumi e con finitura Quercia si armonizza e dà carattere al resto della composizione.

Highlights.

Simplicity of line can be achieved without sacrificing style or convenience. This worktop, with its immaculate forms and Oak finish, blends with and gives character to the rest of the composition.



Raffinato incontro di spessori e volumi.

Una composizione articolata ottenuta accostando pensili alti con basi che si sviluppano orizzontalmente, elementi chiusi alla libreria a giorno che divide il cooking dal living. Una geometria versatile che si esprime anche con l'accostamento di finiture diverse: il piano, dallo spessore di 6 cm, è valorizzato da una superficie con finitura Quercia e si sovrappone alla base con finitura Cemento come l'anta inclinata del pensile.

Sophisticated mix of forms and thicknesses.

A complex composition that combines tall wall units with wide base units, and enclosed units with the open bookcase that divides the cooking and living areas. The versatility of form is matched by the mixing of different finishes: the worktop, 6 cm thick, has an exquisite Oak finish and stands above a base unit with Concrete finish, also used on the wall unit with its slanted door.





Spazio alla creatività.

In cucina è essenziale avere i propri spazi. Per consumare un pasto, preparare una pietanza o anche semplicemente passarci del tempo per dare spazio alla propria vena creativa, culinaria e non. Per questo Miami offre la possibilità di una cucina arredata con uno stile semplice ed elegante che concede spazio alla comodità e alla libertà di movimento.

Space for creativity.

In the kitchen it is essential to have your own space. To have a meal, prepare a dish or even simply spend time there to give space to your creative vein, culinary or otherwise. For this Miami offers the possibility of a kitchen furnished with a simple and elegant style that allows space for comfort and freedom of movement.



Incontri in cucina.



La comodità degli spazi offerti dal design di Miami, permette di vivere la cucina come un luogo di incontro e dialogo. Non solo tra materiali e stili, ma anche tra spazi diversi della casa e tra persone. Grazie alla sua versatilità polifunzionale, Miami coniuga la cucina come spazio di condivisione.

Meetings in the kitchen .

The convenience of the spaces offered by the Miami design allows you to experience the kitchen as a place for meeting and dialogue. Not only between materials and styles, but also between different spaces of the house and between people. Thanks to its multifunctional versatility, Miami combines the kitchen as a sharing space.



Spazi multifunzionali.



Una casa da mostrare come un abito speciale ha bisogno di una cucina che sia un luogo di incontro, di relazione sociale per stare in relax con pochi amici ma capace anche di accogliere un party. Una cucina aperta, capace di interagire con il living senza mai rischiare cadute di stile. Miami esplora ora questa area di gusto, pensata per un pubblico giovane e fashion, sempre aperto al cambiamento.

Multipurpose spaces.

A home to be shown off like a special dress needs a kitchen that is also a meeting-place, a location for socialisation, whether relaxing with a few friends or hosting a full-scale party. An open kitchen, capable of interacting with the living area without ever lowering its tone. Miami now explores this taste in interior design, ideal for the young, fashionable user, always open to change.

Stili che dialogano.

Le diverse composizioni di materiali danno vita a un ambiente originale e completo, racchiuso all'interno di un design semplice ed elegante dove poter vivere appieno la cucina. L'isola dialoga con il piano cottura tramite un top sospeso dove poter consumare un pasto: tre funzioni diverse, tre stili diversi sotto un unico design. Con Miami la cucina diventa uno spazio di condivisione.

Styles that dialogue.

The different compositions of materials give life to an original and complete environment, enclosed within a simple and elegant design where you can fully experience the kitchen. The island communicates with the hob through a suspended top where you can have a meal: three different functions, three different styles under a single design. With Miami, the kitchen becomes a space for sharing.





Più stili, più idee.

Con Miami, il design incontra la creatività.

More styles, more ideas.

With Miami, design meets creativity



Materiali diversi, stile unico.

Marmo e legno: materiali diversi che si combinano
per dare vita a nuove visioni di cucina.

Different materials, unique style.

Marble and wood: different materials that combine to give life
to new visions of the kitchen.





La cucina al centro
della tua casa.

Arreda la tua casa con stile partendo dal design di Miami.

The kitchen at the center of your home.
Decorate your home with style starting with Miami design.

Design moderno e funzionale.

Non basta una cucina bella, deve essere anche comoda, nella composizione e negli spazi. Miami col suo design elegante unisce l'esigenza estetica a quella funzionale, senza sprechi di spazi e senza rinunciare al gusto dell'arredamento.



Modern and functional design.

A beautiful kitchen is not enough, it must also be comfortable, in composition and space. Miami with its elegant design combines the aesthetic need with the functional one, without wasting space and without giving up the taste for furniture.



Internazionale, essenziale.



E la cucina diventa un modo per essere visibile, riconosciuto, ma sempre in maniera elegante, secondo un mood che del minimalismo sembra aver preso la propensione a ripulire la forma degli arredi per arrivare a un'essenzialità che può vivere ovunque nel mondo. Proprio come il pubblico che la sceglie: fantasioso, pragmatico, libero e soprattutto capace di star bene ovunque. Ecco allora che lo spazio diventa di volta in volta una "grande piazza", un luogo intimo o semplicemente un ambiente capace di ospitare la vita quotidiana.

International, essential.

The kitchen becomes a way of gaining visibility and recognition, but always with impeccable elegance, in a mood that seems to have borrowed minimalism's habit of stripping down the forms of furniture to a simplicity that can look good anywhere in the world. Just like the people who choose it: imaginative, pragmatic, free and above all able to be happy anywhere. So this interior has multiple identities: an open meeting-place, an intimate living space or just a room for everyday life.





Variazioni sul tema del neutro.

Variations on a neutral theme.

Linee essenziali, massima funzionalità.

A misura di ogni giorno con una cucina che incontra il sogno di un progetto capace d'integrare le funzioni tradizionali con quelle contemporanee.

Miami interpreta il cambiamento, mettendo in mostra il suo mood più informale.

Di fronte all'area operativa, un sistema di colonne e spazi a giorno, raccordati da un grande piano di lavoro, creano un habitat da vivere senza condizionamenti.

Simple lines, maximum convenience.

Styled for daily life, a kitchen that fulfils the dream of combining both traditional and contemporary functions. Miami interprets change by revealing its most casual mood. Facing the working area is a system of tall units and open spaces, connected by a large worktop, creating a habitat where life can be lived in freedom.



La curva esprime modernità.

Perché la vita non è mai una linea retta ma un progetto in continua evoluzione. E' quindi importante essere pronti a captare il cambiamento, a cogliere segnali talvolta impercettibili. Un concept che si ritrova anche in Miami che ora modifica lo spazio domestico attraverso una progettazione che non contempla solo elementi rigorosamente lineari ma introduce anche elementi dalla geometria sinuosa.



The curve, expression of modernity.

Because life is a continually evolving project, and never a straight line. So it is important to be ready to respond to changes, picking up signs that may be imperceptible. A concept also found in Miami, which now modifies domestic space through design that includes not only severely straight elements but also units with sinuous curves.





Informazioni Tecniche
Technical Information

PROPOSAL 01



PAG. 04 - 05

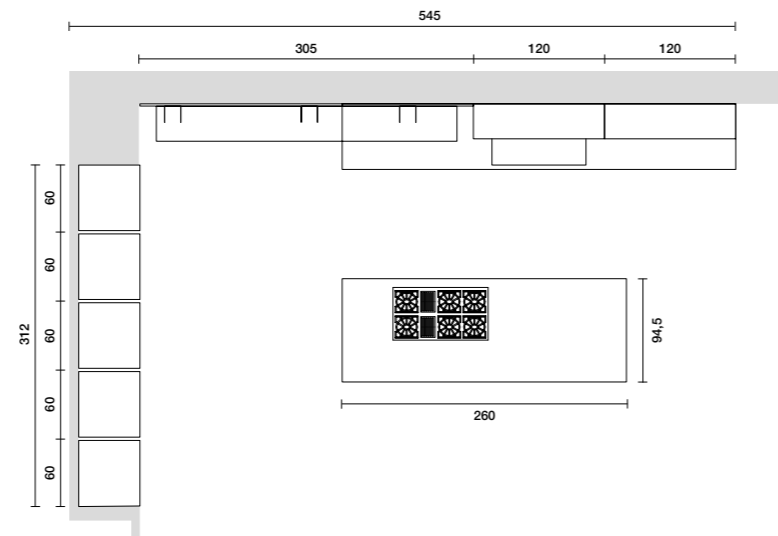

Finitura - Finish
Noce Cognac
Spatolato scuro
Laccato Bianco Ral 9010

Top - Top
Pietra Nera sp. 4 ABS
Noce Cognac sp. 4 ABS

Maniglia - Handle
Gola Antracite

PROPOSAL 03



PAG. 18 - 19

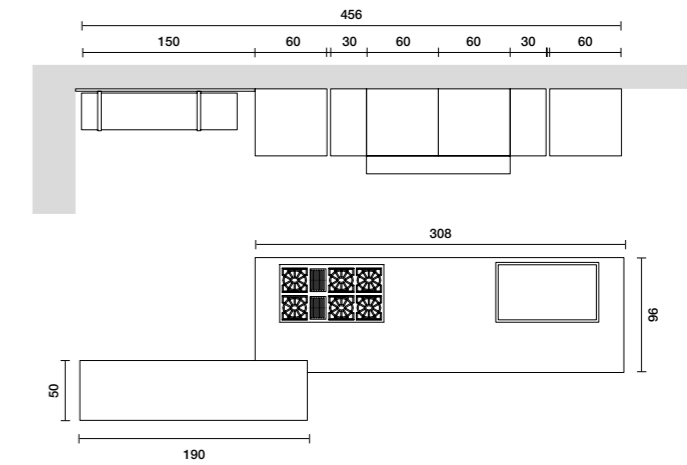

Finitura - Finish
Rovere rigatino
Uisone

Top - Top
Pietra Nera sp. 4 ABS
Folding Rovere rigatino sp. 6

Maniglia - Handle
Gola Oro

PROPOSAL 02



PAG. 10 - 11

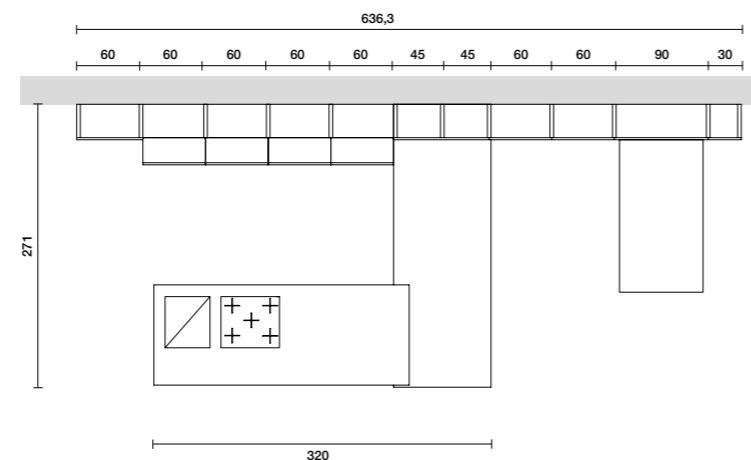

Finitura - Finish
Rovere rigatino
Laccato Bianco ral 9010 opaco
Laccato Grigio Ral 7022 opaco

Top - Top
Bianco sp. 4 ABS

Maniglia - Handle
Profilo Moka

PROPOSAL 04



PAG. 26 - 27

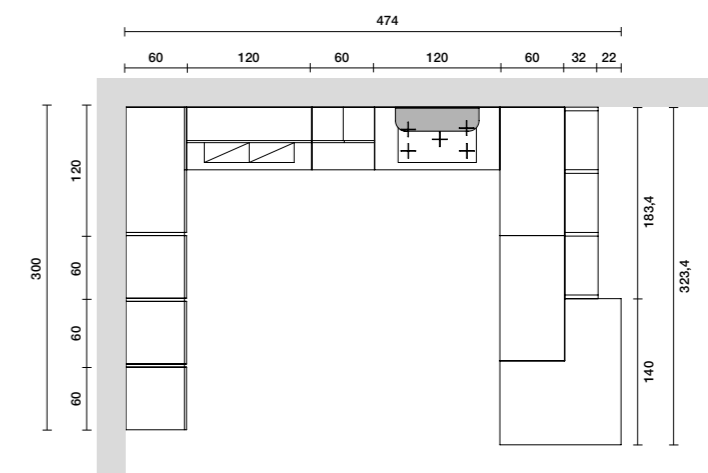

Finitura - Finish
Quercia Ø788
Cemento 5556
Laccato Grigio RAL 7022 opaco

Top - Top
Stone 545 sp. 2 ABS
Quercia Ø788 sp. 6

Maniglia - Handle
Gola Antracite

PROPOSAL 05



PAG. 32 - 33

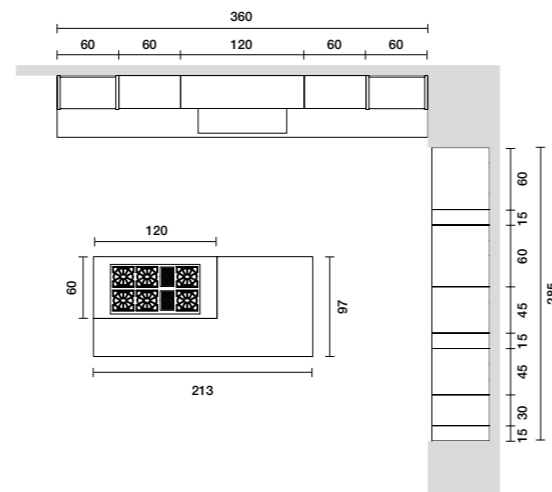

Finitura - Finish
Rovere tavolato
Rovere scuro
Acciaio Bronzo Antico

Top - Top
Rovere tavolato sp. 4 ABS
Acciaio satinato sp. 6

Maniglia - Handle
Miami Ø1

PROPOSAL 07



PAG. 42 - 43

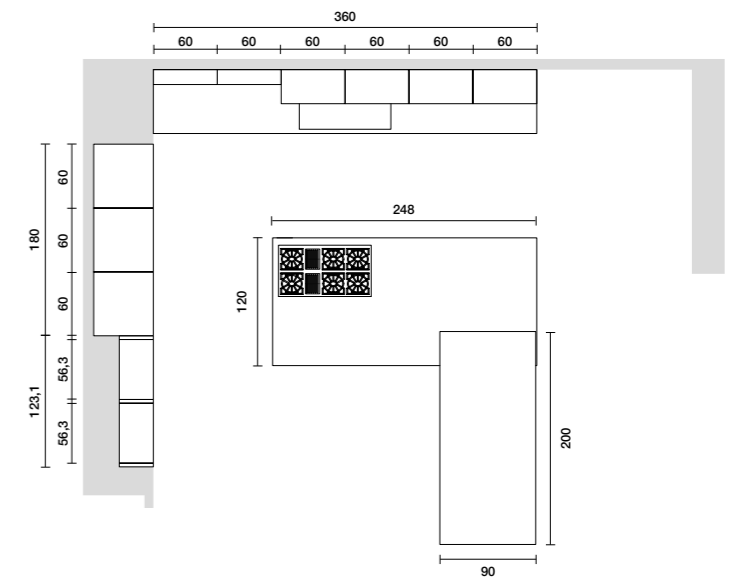

Finitura - Finish
Noce Canaletto
Acciaio anticato
Marmo Bianco

Top - Top
Marmo Bianco sp. 4 ABS
Piano massello scortecciato sp. 5

Maniglia - Handle
Punto Antracite
Linea Antracite

PROPOSAL 06



PAG. 40 - 41

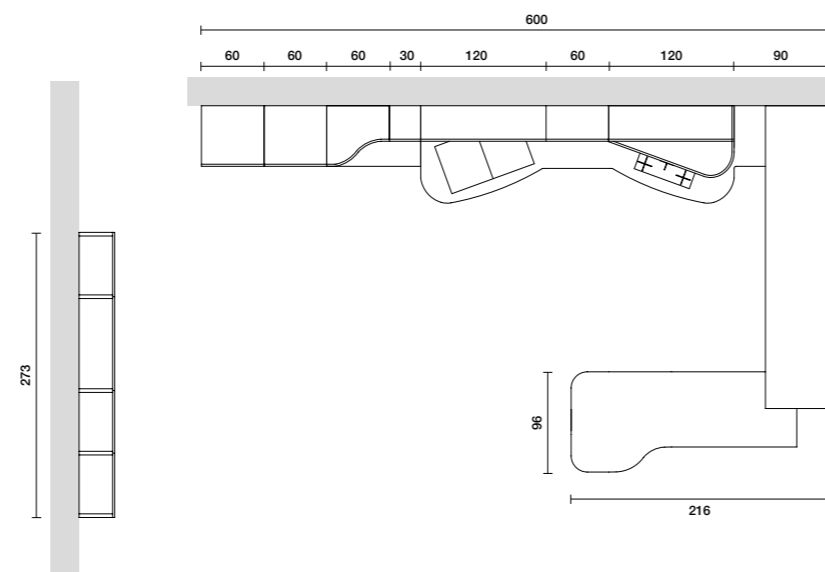

Finitura - Finish
Rovere scuro
Laccato Tortora Ral 1019 lucido

Top - Top
Stone 545 sp. 4 ABS
Cemento 6066 sp. 4 ABS

Maniglia - Handle
Miami Ø4

PROPOSAL 08



PAG. 48 - 49

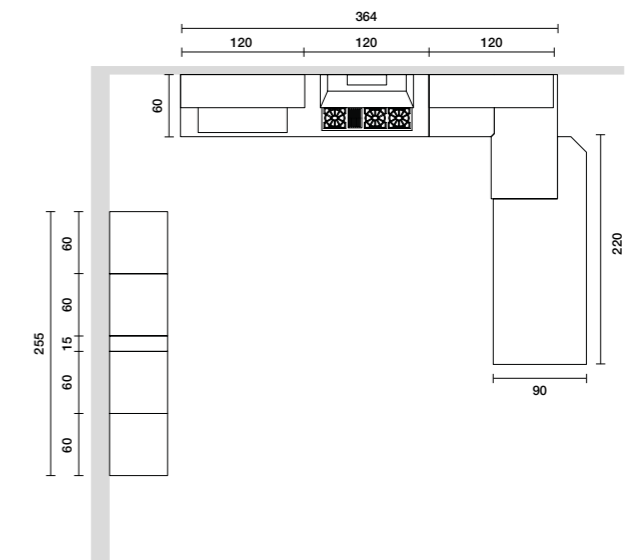

Finitura - Finish
Rovere nodato
Metallo
Laccato Bianco Ral 9010 opaco

Top - Top
Acciaio satinato sp. 4
Botticino sp. 4 ABS

Maniglia - Handle
Miami Ø5

PROPOSAL 09



PAG. 56 - 57

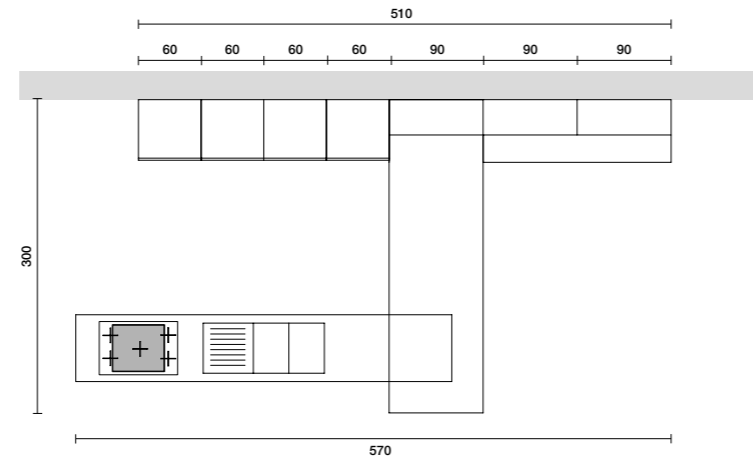

Finitura - Finish
Quercia Ø788
Laccato Bianco Ral 9010 opaco
Laccato Marrone RAL 8028 opaco

Top - Top
Marmo di Carrara sp. 3
Sabbia 3510 sp. 4 ABS

Maniglia - Handle
Miami Ø2

PROPOSAL 10



PAG. 62 - 63

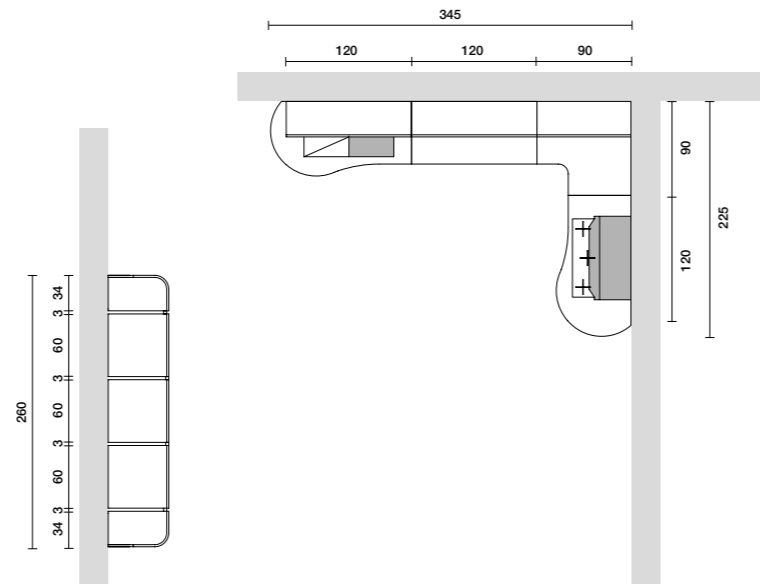



















Finitura - Finish
Laccato Bianco Ral 9010 opaco

Top - Top
Bianco Wraky sp. 2 ABS

Maniglia - Handle
Gola bianca

Sistemi di apertura
Opening Systems

MANIGLIE - HANDLES

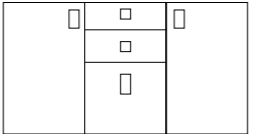
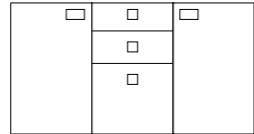
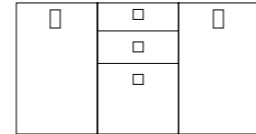
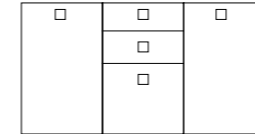
 MOD.1005128 Int. 128 mm. Maniglia incasso Finitura antracite Anthracite finish	 MOD.1005128 Int. 128 mm. Maniglia incasso Finitura satinata Satin finish	 MOD.404 Int. 160 mm. Finitura satinata Satin finish	 MOD.404 Int. 160 mm. Finitura antracite Anthracite finish	 MOD.404 Int. 320 mm. Finitura satinata Satin finish	 MOD.404 Int. 320 mm. Finitura antracite Anthracite finish
 MOD.403B Int. 160 mm. Finitura antracite Anthracite finish	 MOD.406B Int. 160 mm. Finitura antracite Anthracite finish	 MOD.387B Int. 160 mm. Finitura satinata Satin finish	 MOD.328 Int. 160x192 mm. Finitura satinata Satin finish	 MOD.1005 Int. 192 mm. Finitura cromata Chrome finish	 MOD.12861 Int. 160 mm. Finitura cromata Chrome finish
 MIAMI 01 Int. 320x192x128 mm. Finitura satinata Satin finish	 MIAMI 02 Int. 128x32 mm. Finitura satinata Satin finish	 MIAMI 03 Int. 320x160x96 mm. Finitura satinata Satin finish	 MIAMI 04 Int. 256x128x64 mm. Finitura satinata Satin finish	 MIAMI 05 Int. 320x160x96 mm. Finitura satinata Satin finish	
 MIAMI LINEA Finitura satinata Antracite Satin finish Anthracite	 MIAMI PUNTO Finitura satinata Antracite Satin finish Anthracite	 MIAMI LINEA VERTICALE	 MIAMI LINEA ORIZZONTALE	 MIAMI LINEA VERTICALE	 MIAMI PUNTO

ANTA - DOOR CROSS



2 cm
Scala 1:1

Sistema di apertura
Opening systems

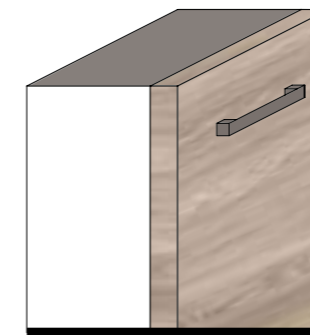

Maniglia
Handle

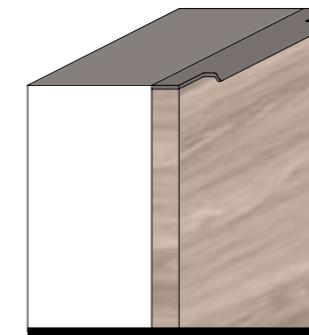

Maniglia Profilo
Handle Profilo

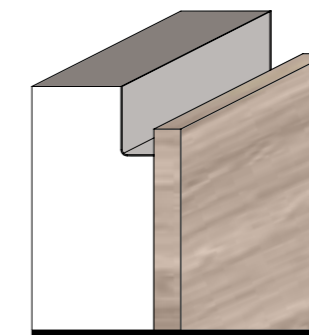

Life
Life

Anta Essenza:
in melaminico sp.20 mm.
bordo 4 lati con ABS in tinta.

Wood color Door:
in melamine, thickness 20 mm,
edged on all 4 sides
with matching colour ABS.

Anta Laminata:
In laminato HPL sp.20 mm.
bordo 4 lati con ABS in tinta.

Laminate Door:
In HPL laminate, th.20 mm,
edged on 4 sides in ABS
in matching colour

Anta Laccata:
Supporto in MDF sp.20 mm.
laccato opaco o lucido con
vernice poliuretanica.

Lacquered Door:
Support in MDF, thickness 20 mm,
matte or glossy lacquered
with polyurethane varnish.

MANIGLIA PROFILO - HANDLES



Brill

Moka

Finiture
Finishes

FINITURE DISPONIBILI - AVAILABLE FINISHES

Essenza
Essence



Rovere tavolato - RT



Rovere scuro - RS



Rovere nodato - RN



Rovere rigatino - RR

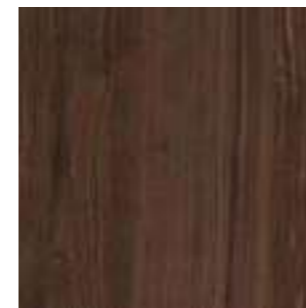

Noce cognac - NO*

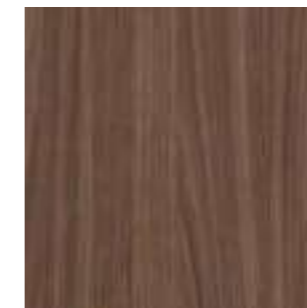

Noce canaletto - NN



Rovere nero - NE

Spatolato



Spatolato bianco - SP

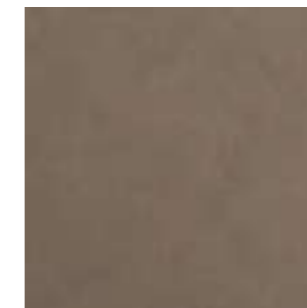

Spatolato bronzo - SB



Spatolato chiaro - IR*

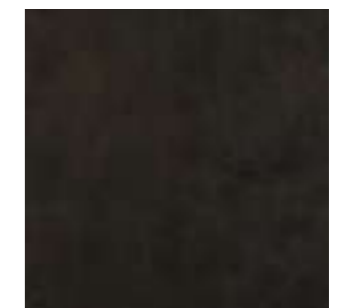

Spatolato scuro - GC*

Reflex

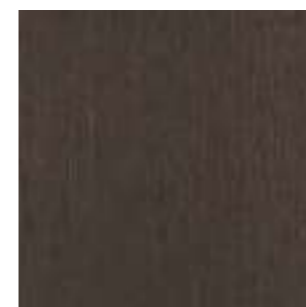

Bronzo - BR



Metallo - ME



Uisone - UI

* Finiture compatibili con programma Spar giorno notte
Spar kitchen and dining bedroom programme compatible finishes

FINITURE DISPONIBILI - AVAILABLE FINISHES

Laccati
Lacquered

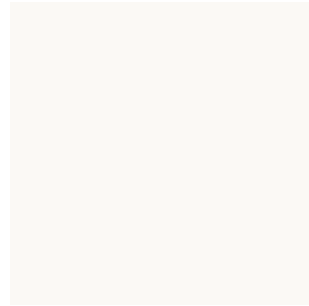

Bianco RAL 9010

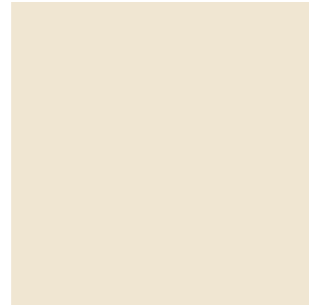

Avorio RAL 1013



Tortora RAL 1019



Marrone RAL 8028



Grigio RAL 7030



Blu RAL 5009



Blu RAL 5020



Giallo RAL 1012



Arancio RAL 2004



Rosso RAL 3003

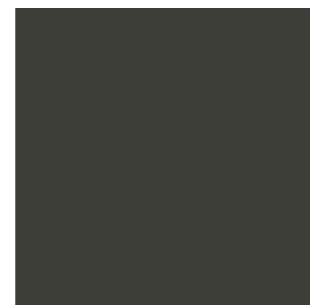

Grigio RAL 7022

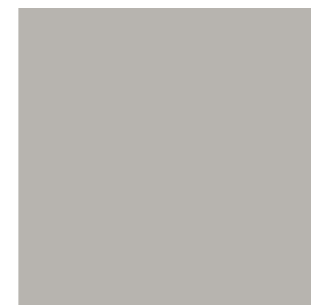

Grigio seta*

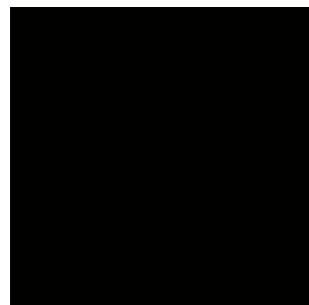

Nero RAL 9005

Laminati
Laminates



Cemento* - CE



Pietra* - PI



Quercia* - QU



Pietra nera - PN



Marmo bianco - MB



Botticino - BO

Acciaio
Steel



Rame antico - RA



Bronzo antico - BA

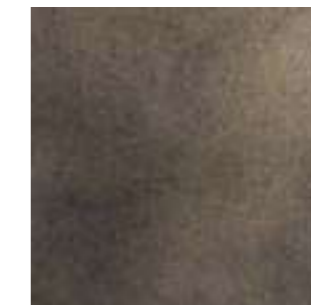

Ottone antico - OA



Acciaio antico - AA



Acciaio satinato - AS



Acciaio mate - AM

Cover in acciaio inox AISI per ante o fianchi.
Le finiture anticate sono sempre in acciaio laccato mentre la finitura Mate ha l'effetto "Usurato" naturale

Cover in AISI stainless steel for doors or sides.
The antiqued finishes are always in lacquered steel while the Mate finish has a natural "worn" effect

* Finiture compatibili con programma Spar giorno notte
Spar kitchen and dining bedroom programme compatible finishes

FINITURE GOLLA - GOLLA FINISHES



Brill

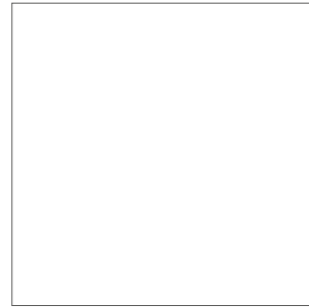

Bianca



Antracite



Laccato RAL con maggiorazione
Ral lacquer colors are all with an extra price
Coût supplémentaire pour laquage RAL

Zoccolo PUC di serie
Baseboard



Alluminio



Antracite

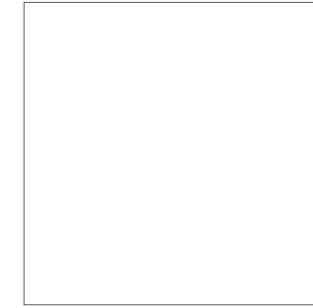

Bianca



Laccato RAL con maggiorazione
Ral lacquer colors are all with an extra price
Coût supplémentaire pour laquage RAL

N.B: Gamma completa gole alluminio lineare o curvo comprese nel prezzo di listino della base
Gole antracite o bianco lineari comprese nella base
Gole curve antracite o bianco disponibili solo laccate con maggiorazione

N.B: linear or curve aluminium plinths are included in the base cost.
Linear anthracite or white plinths are included in the base cost.
Anthracite or white curves plinth only available with an extra price.

N.B: Gamma completa zoccolo alluminio lineare o curvo compreso nel prezzo di listino
Zoccoli lineari antracite o bianco compresi nel prezzo di listino
Zoccoli curvi antracite o bianco disponibili solo laccati con maggiorazione

N.B: Complete range of linear or curved aluminum plinth included in the list price
Linear anthracite or white plinth included in the list price
Curved anthracite or white plinths available only lacquered with surcharge





Spararreda S.r.l

Via dell'Automazione 15
61122 Pesaro
Loc. Chiusa di Ginestreto (PU)

Tel +39 0721 48511
Fax +39 0721 482074

spar@spar.it - www.spar.it